

**YONGNUO**  
DIGITAL

# YN500EX

## USER MANUAL



Before use, please READ this user manual carefully in order to ensure your safety. Keep it properly for reference in the future.

For Canon

English

## **I. Warning**

To avoid fire or electrical shock, do not expose this product to rain or moisture.

To avoid short circuit, be sure the batteries contacts are securely packed and in accordance with local provision when handling the batteries.

Please place the batteries and the parts which can be swallowed mistakenly away from children. Contact a doctor immediately when it occurs.

To avoid possible injury to eyes, do not use the flash light in a short distance from the eyes.

To avoid possible safety accident, do not use the flash light on the people who need a high degree of attention.

Please take out the batteries and stop using immediately in case of below.

- This product is dropped or shocked seriously and the inner part of the product is bared.
- If the battery leaks corrosive liquids, please take out the battery with gloves.
- The product gives off strange smell, smokes or heats.

Do not disassemble or maintain this product. Touching the internal high voltage circuit will cause electric shock.

## II. Features

- **SUPPORTS HIGH-SPPEED SYNC FLASH**

With high-speed sync (FP flash), the YN500EX can synchronize with all shutter speeds, the maximum shutter sync up to 1/8000.

- **COMPATIBLE WITH N's and C's WIRELESS FLASHING SYSTEM**

One YN500EX is able to respectively accept internal flashing of 580EX II, SB-900/800/700, 7D/60D/600D, C order of N's internal flashing and ST-E2 wireless signal, achieves external TTL and manual flashing.

- **LARGE-SIZE LCD DISPLAY**

Flashing function can be checked and set on a more clearly and subjectively basis and can be used more conveniently by Large-size LCD display.

- **GN53 @ ISO100, 105mm**

YONGNUO brand-new range of speedlites with high index support TTL, M, Multi flashing model.

- **MULTIPLE TRIGGER MODE SUPPORTED**

YN500EX can be triggered by the camera set-top, built-in or main-controlled flashing command, S1 and S2 preflashing.

- **SUPPORTS MOTOR ZOOMING (24~105mm)**

The covered focal length will vary between 24~105mm on the lamp adapter by operating the zoom button on the flash light.

- **COMPREHENSIVELY SUPPORTS TTL FUNCTIONS**

HSS, FEC, FEB, Rear-curtain sync, FE lock, Modeling Light, Canon camera menu accessible.

- **REMOTE WIRELESS TRIGGER SUPPORTED**

The YN500EX supports remote wireless trigger function, which makes the Sc/SnS1/S2 mode can be used in outdoor environment and the wireless trigger distance is as long as 15 meters.

- **SOUND PROMPTING SYSTEM**

When the sound prompting system is enabled, the different sound ways will prompt the different working conditions of the speedlite so as to make you focus on shooting only.

- **COMPLETED WITH PC SYNCHRONOUS INTERFACE**

It makes things easier on lightening the speedlite synchronously by using PC synchronous line.

- **FAST CURRENT-RETURN SYSTEM**

The time for full gloss output current-return will only take you 3 seconds; you can get fast current-return experience even without brand-new batteries, which will only take you 4~5 seconds.

- **ADVANCED OPTION FUNCTIONS**

YN500EX has advanced options setting function, where you can self-define the functions of the speedlite on your own requirements.

- **AUTOMATIC SAVING FUNCTION**

YN500EX can automatically save the operation currently used for your future use.

### **III. Quick Start**

**If you don't have much time to read the whole user manual, we advise you to read this section.**

1. Please avoid the excessive use of the output with maximum power. It can effectively extend the service life of this product.
2. You can understand the function of each button by pressing them and observing the displayed content.
3. Press the [High-speed/Rear-curtain sync] button to select High-speed sync function.
4. Press [MODE] button to select TTL/M/Multi mode, holding [MODE] for a while to select remote trigger model, and then press [MODE] again to select Sc/Sn/S1/S2.
5. Set slave group A/B/C by operate [High-speed/rear-curtain] and [MODE] buttons, set channels (1, 2, 3, 4) by [High-speed/rear-curtain] and [ZOOM] buttons.
6. Press the [UP], [DOWN], [LEFT], and [RIGHT] buttons to adjust the parameters of speedlite quickly at the current mode. For some parameters, the [OK] button in the center is needed to be pressed for setting.
7. Select the function of advanced option through [Illumination/Sound] and [MODE] buttons. See the section of “Advanced Setting” for the content.
8. This product provides TTL, M, and Multi mode.

## IV. Nomenclature

1. Reflection board
2. Wide-angle diffuser
3. Flash head
4. PC port (for input)
5. Contact cover
6. Battery chamber's cover
7. Wireless trigger sensor
8. Remote indicator
9. AF-LED
10. Locking ring
11. Hot shoe stand
12. Sound port
13. Hot shoe contact

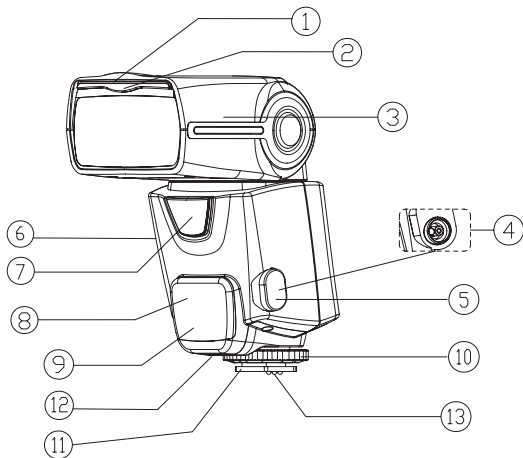

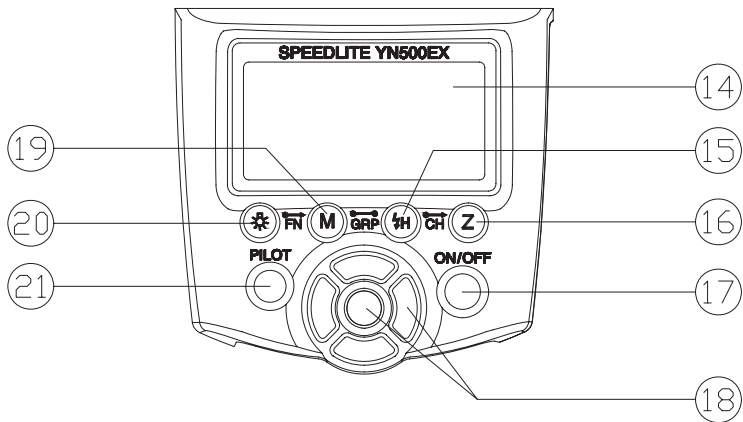

- 14. LCD screen:** Display all functions and application setting of speedlite, convenient for users' examination and quick setting.
- 15. High-speed/Rear-curtain synchronous button:** High-speed and rear-curtain sync synchronous function can be set by directly operating this button.
- 16. ZOOM button:** Directly operating [ZOOM] button can adjust the zoom rang of lamp holder (auto, 24, 35, 50, 70, 80, 105mm).
- 17. Power switch (ON/OFF):** Press this button for about 2 seconds and turn on or off the power of speedlite.
- 18. Selection/setting button set:** Include [Left], [Right], [Up], [Down] and [Ok] at the center; [Left] and [Right] button can set exposure compensation, output power, advanced options parameter, stroboscopic flash times, stroboscopic flash frequency; [Up] and [Down] button can set exposure bracketing, fine brightness adjustment and advanced options number.
- 19. MODE:** Under the camera set-up state, flash mode shall switch between TTL/M/Multi with every pressing; under wireless off-camera state, trigger mode of the speedlite shall switch between Sc/Sn/S1/S2 with every pressing. And if press [MODE] for a long time, shift between the camera set-up and off camera state can be made.
- 20. Backlight/voice switch:** LED backlight can be turned on or off by pressing this button for a short time; and voice prompt function of the speedlite shall be turned on or off by pressing this button for about 2 seconds.
- 21. Charge indicator/test button (PILOT):** Red lamp means charge is completed, flash can be made; green lamp means charge is being on, and press this button (PILOT), the speedlite shall send test flash.



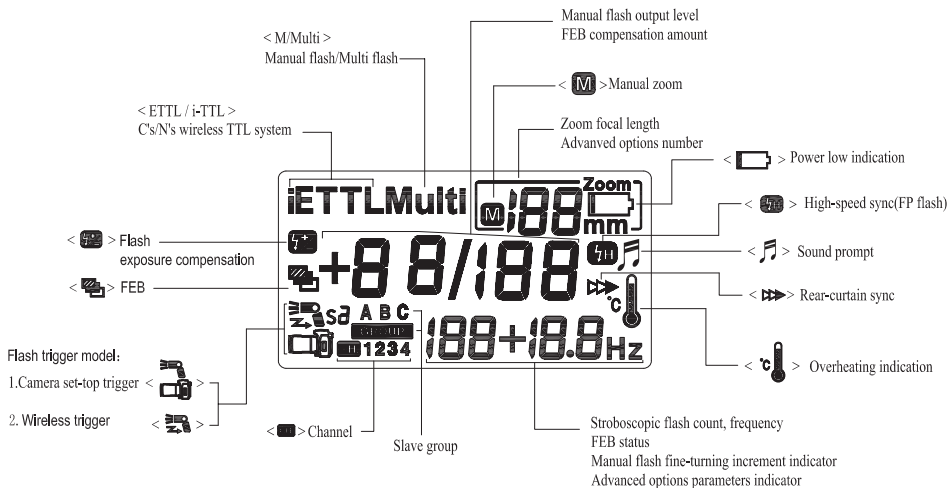

## V. Installation Instruction

### 1. Install Batteries

Slide the batteries chamber's cover in the direction of the arrow.

Insert the batteries according to the label inside battery chamber.

Make sure the direction of the batteries' polarity is correct.

Close the battery chamber cover in the direction of the arrow.

### 2. Attaching to the Camera

Loosen the locking ring by turning it in the direction of the arrow.

Slip the speedlite hot shoe stand into the camera hot shoe stand until it stops.

Turn the locking ring in the direction of the arrow tighten.

To detach the speedlite, loosen the locking ring by turning it in the opposite direction.

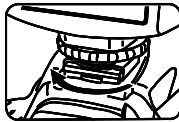
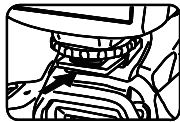
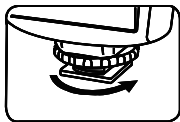
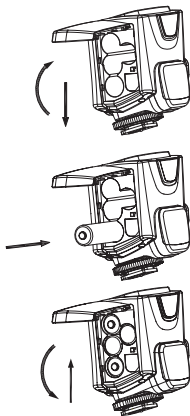

## VI. Basic Functions

### 1. Button Operation:

Parts	Operation
[ON/OFF]	Turn on or off the power of speedlite by pressing this switch for a long time. It is recommended to take out battery after turning off the power of the speedlite.
[MODE]button	When use the speedlite roof, flash mode shall switch between TTL/M/Multi with every pressing. When the speedlite is under wireless off-camera application mode, trigger mode of the speedlite shall switch between Sc/Sn/S1/S2. And shift between roof or off-camera state can be made by pressing this button for a long time.
[Backlight/Sound] button	LCD backlight can be turned on or off by pressing this button for a short time; and sound prompt function of the speedlite shall be turned on or off by pressing this button for about 2 seconds. And if keep this button and press [MODE] button, it can enter into advanced options setting state.
[High-speed/ rear-curtain sync ] button	When use the speedlite roof, flash mode shall switch between high-speed sync/rear curtain sync with every pressing. When the speedlite is under off-camera application mode, together with [ZOOM] button set, this button can set communication channel (1/2/3/4), and with [MODE] button set, this button can set slave group (A/B/C).
[ZOOM] button	Zoom range of lamp holder (auto, 24,35, 50, 70, 80, 105mm) can be adjusted by directly operating [ZOOM] button.
Selection/setting button set	Include [Left], [Right], [Up], [Down] and [Ok] at the center; [Left] and [Right] button can set exposure compensation, output power, stroboscopic flash times, stroboscopic flash frequency, advanced options parameter, [Up] and [Down] button can set fine brightness adjustment and advanced options number.
[PILOT] button	Flash output brightness test can be made by pressing this button.

**Meaning of [Charging indicator]**

Status of [Charging Indicator]	Meaning	Operation
The red light is lit	The speedlite is fully charged, and can be used.	Normal
The green light is lit	The speedlite has not been fully charged.	Waiting for the completion of charging.
The green light blink	The power is not enough, and the speedlite is about to shut down.	Please replace the batteries.
The red light blink	The speedlite is sleeping.	Press every button to wake it up

**The meaning of [Sound indicator]**

The sound form	Meaning	Operation
Tick twice	a. The sound indicator is enabled; b. The speedlite is started or flash is ok.	Normal
Three tick, two times	The exposure may be over	Adjusting exposure compensation or charging shooting condition
Tick tick tick	The exposure may be excessive	Adjusting exposure compensation or charging shooting condition
Tick—tick twice—tick twice	The speedlite is in the charging or overheating protection state.	Waiting for the completion of charging; waiting for about 3 minutes to cancel the protection.
Tick—a long sound	The speedlite is fully charged, and can be used.	Normal
Tick—tick —tick	The power is not enough and the speedlite is going to be shut down.	Replace the batteries.

## 2. Power-on and Power-off

The power of the speedlite can be turned on or turned off by pressing [Power Switch] button 2 seconds. It is suggested that the batteries should be taken out after power of speedlite is turned off though this button.

After turned on the power of the speedlite, the charging indicator is red, which indicates the speedlite is available. If the charging is not completed within 20 seconds, the low power indicator will be displayed on LCD panel, and speedlite will automatically shutdown, you need to replace with new batteries.

You may press the [PILOT] button to test whether the speedlite works normally.

After use, turned off the speedlite by pressing the [ON/OFF] button.

## 3. ETTL Mode

In this mode, the metering system of this camera will detect flash illumination reflected back from the object so as to automatically control flash output, and HSS, FEC, FEB, FEV, Rear-curtain, Modeling light, and CANON camera menu accessible(CANON version only) is supported.

You can set exposure compensation for flash by pressing [Left] and [Right] buttons, the flash exposure compensation amount can be set up to  $\pm 5\text{EV}$  in 1/3-stop or 1/2-stop increments.

## 4. M Mode

In M mode, you can set flash brightness as you like, and adjust flash brightness by [Left], [Right], [Up] and [Down] button. Adjustment range of flash brightness is  $1/64 \sim 1/1$ , and the brightness can be divided into 7 grades, while every grade has three grades at most for fine adjustment, and takes mixing grade 0.3EV, 0.5EV or 0.3/0.5EV as

adjustment increment, totally 25 -grade fine adjustment at most; adjust whole grade brightness with [Left] and [Right] button, and make fine adjustment with [Up] and [Down] button, and the adjustment result shall be directly shown on the LED screen. At shooting time, you only need to set flash brightness, adjust the camera and press the shutter; the speedlite shall flash according to the sync signal of the camera.

## **5. Multi Mode**

With Multi mode, a rapid series of flashes is fired. The speedlite will flash according to the output levels, flash times and frequency you set. Use [LEFT], [RIGHT] buttons to adjust output power, flash times and frequency. The adjustment scope of output level is 1/64-1/32-1/16-1/8-1/4, the scope of flash times is from 1 to 100, and the scope of flash frequency is from 1 to 100. Adjustment method: Please press [OK] button to select setting items (flash) and use the [LEFT] and [RIGHT] buttons to adjust the parameters. After the setting is completed, press [OK] button to confirm the setting.

NOTE: The charging speed of speedlite is slow under the situation that the electricity quantity of the battery is insufficient, which may cause the occurrence of the high-frequency flash. Please reduce the flash frequency or change new battery under this situation.

## 6. Sc/Sn and S1/S2 Mode

Set the speedlite to be Sc by pressing the [MODE] for a long time, and then operate [MODE] button, and the speedlite shall switch between Sc/Sn/S1/S2, and these four modes all shall be applied as off-camera dependent unit in order to create different lighting effects.

**Sc/Sn** mode can separately accept 580EX II, SB-900/800/700, 7D/60D/600D built-in flash, Nikon camera C-command, SU-800 and ST-E2 wireless signal, supporting 4 channels and realizing TTL and manual wireless flash. When use Sc/Sn and S1/S2 mode, wireless trigger sensors can be adjusted to face master lamp by rotating speedlite holder. Before shooting, YN500EX and master unit should be set at a same communication channel. Setting method: Keep [High-speed/rear-curtain sync] and operate [ZOOM] button to select communication channel (1, 2, 3, 4). In Sc/Sn mode, brightness of YN500EX speedlite will be totally controlled by master unit.

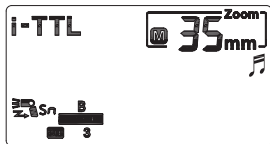

**S1 and S2** modes are suitable for MANUAL flash environment and TTL flash environment respectively. Under these two modes, the way to adjust the output level is like that in M mode.

**S1 mode:** It will work with the first work of the master flash synchronously, with the result consistent with the use of radio slave. To use this mode correctly, the master flash should be set at manual flash and the TTL flash system with preflight function and the red-reduction function with multiple flashes should not be used.

**S2 mode:** It is also called “pre-flash cancel mode”. This mode is similar with S1 mode, but it can neglect the pre-flash given by TTL flash. Therefore, it can support the main flash working in TTL mode. In particular, if S1 mode cannot flash correctly and synchronically with your internal flash, you can try to use S2 mode.

The following situation shall be avoided when the S1 and S2 modes are used: the red eye reduction function of the main light is used; the order mode (nikon) or wireless mode (canon) of the main light is used; the ST-E2 is used as the flash controller. **Otherwise, please set the speedlite as Sc/Sn.**

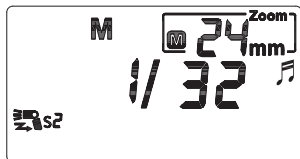
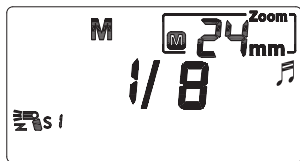



## **7. Menu Access of Camera (only for the more recent Canon models)**

You can control the speedlite by accessing to camera menu on the recent canon models which support E-TTL. On the Flash Control Menu, you can set some parameters through “External flash func. setting” and “ External flash C. Fn setting”, for example, Flash mode, Shutter sync., FEB, Flash exp. comp, Zoom, Wireless set., and advanced setting etc.

## **8. Test Flash**

Whether in any mode, you can press PILOT button to test if the speedlite flash normally. When testing the flash, the speedlite will give flash at relevant output level in accordance with the chosen output power setting.

## **9. Power Saving Mode**

YONGNUO designs a power saving mode for YN500EX, and the mode can be achieved by setting advanced options function, such as <SL Sd 10>. Operate [Backlight/voice switch]+[MODE] buttons to enter into setting state, and then select the option numbered 01 with [Up] and [Down] button, and set the state to be SL EP - - with [Left] and [Right] button, “Automatic power off” will be closed, and when the state is set to be SL EP on, “Automatic power off” will be opened up.

Power saving modes set by advanced option are as following:

NO.	Scope of Application	Options	Power saving mode
01 SL EP	All modes	--	Power saving mode is turned off
		on	Power saving mode is turned on
10 SL Sd	SL/S1/S2	60	Power automatic off of the slave unit is 60 minutes
		10	Power automatic off of the slave unit is 10 minutes
11 SL OF	SL/S1/S2	1H	Slave auto power off cancel within 1 hours
		8H	Slave auto power off cancel within 8 hours
E1 SE OF	Others	3/5/10/30/ 1H/2H/3H/ 4H/5H/ --	Sleep after idle time of 3 minutes/5 minutes/10 minutes/30 minutes/1 hour/2 hours/3 hours/4 hours/5 hours. After it enters the sleep state, it powers off automatically after keeps the same idle time. --: No dormancy, no power off

## 10. Overheating Protection

If the speedlite is used too frequently, the overheating protection function will be triggered; the OVERHEATING indicator will be displayed on LCD panel. And the speedlite will be locked. In such case, please wait for about 3 to 5 minutes to cancel the protection before continuing use. Please try to use 1/4 output or lower when rapid shooting is needed to prevent the effect on the shooting.

## 11. ZOOM Setting the Flash Coverage

**Auto Zoom:** Press the [ZOOM] button to adjust the flash coverage (auto/24 / 35 / 50 / 70 / 80 / 105mm), if <M> is not displayed, the flash coverage will be set automatically (35mm for default coverage). Attaching the speedlite to the camera, the flash coverage will set automatically to match the lens focal length.

**Manually set the zooming position:** Press the [ZOOM] button to adjust the flash coverage, if <M> is displayed, pressing the [ZOOM] button, the coverage focal length of the flash will switch in circle of (24, 35, 50, 70, 80, 105mm).

**NOTE:** Using wide-angle-diffuser, the flash coverage will then be extended for 14mm.

## 12. Sound Prompt

When the sound prompt function is activated, the speedlite will give out different sound to indicate the working state. See the following table for the meaning of sound.

The sound form	Meaning	Operation
Tick twice	a. The sound indicator is enabled; b. The speedlite is started or flash is ok.	Normal
Three tick, two times	The exposure may be over	Adjusting exposure compensation or charging shooting condition

Tick tick tick	The exposure may be excessive	Adjusting exposure compensation or charging shooting condition
Tick—tick twice—tick twice	The speedlite is in the charging or overheating protection state.	Waiting for the completion of charging; or waiting for about 3 minutes to cancel the protection.
Tick—a long sound	The speedlite is fully charged, and can be used.	Normal
Tick—tick —tick	The power is not enough and the speedlite is going to be turned off	Replace the batteries.

### 13. PC Sync port (for input)

By connecting to the PC sync port, you can make the flash synchronously.

### 14. Automatic setting saving

The speedlite will automatically save the current settings in order to let you have a simpler use next time after boot.

## VII. Wireless Flash System

One YN500EX is able to respectively accept internal flashing of 580EX II, SB-900/800/700, 7D/60D/600D, C-commander of N's internal flashing and ST-E2 wireless signal, achieves external TTL and manual flashing.

**Sc:** Indicating that it can only receive wireless signal from Canon system, avoiding Nikon system.

**Sn:** Indicating that it can only receive wireless signal from Nikon system, avoiding Canon system.

Any flash exposure compensation, FEB, FE lock, manual flash, and stroboscopic flash settings set with the master unit will be automatically transmitted to the YN500EX.

Even with multiple YN500EXs, all of them will be controlled in the same way via wireless.

**1. Master unit setting:** To use 580EX II, SB-900/800/700, 7D/60D/600D with built-in commander mode, Nikon c-commander and ST-E2. For the setting method, please refer to your master instructions.

### 2. Slave unit setting

Take YN500EX as slave unit. Set the speedlite to be Sc by pressing [MODE] for a long time, and then switch it to be Sn by pressing [MODE] button, and set dependent unit group (A, B, C) by combined application of [High speed/rear-curtain sync] and [MODE], and select communication channel (1, 2, 3, 4) by combined application of [High-speed/rear curtain sync] and [ZOOM].

**Notes:** When set slave unit set or communication channel, it is required to first keep [High-speed/rear curtain sync] button, and then operate [MODE] or [ZOOM] button.

### 3. Multi-Speedlite, Wireless lighting configurations

You can create two or three slave groups to make shooting effect better meet your requirements, and set flash ratio for TTL autoflash shooting of master, as well as manual flash output, frequency flash etc.

#### (1). Wireless flash of two slave units made up by YN500EX

- Wireless option setting: Sc/Sn for operation
- Communication Channel setting: 1, 2, 3, 4
- Groups setting: Set one YN500EX as group A, and set the other one as group B.
- Master unit setting: Set the communication channel, Set the flash ration of master unit A: B or A: B: C. You can conduct flash shooting.

#### (2). Wireless flash with three YN500EX speedlites

- Wireless option setting: Sc/Sn
- Channel setting: 1, 2, 3, 4
- Groups setting: Set three YN500EX speedlites as group A, group B and group C respectively.
- Setting master and shooting: Please select the ratio<A: B C>.

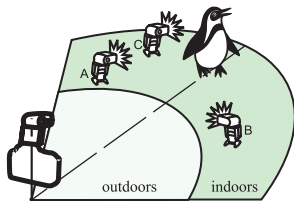
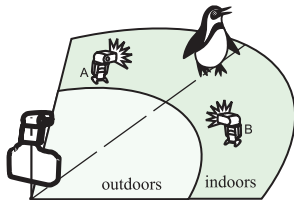

Press the test button of master to test whether the flash works normally; if the flash does not fire, adjust the slave unit's angle toward the master unit and distance from the master unit.

**NOTE:** If ratio <A: B> is set, the slave unit in group C will not fire.

If you have the slave group set to <A> for three slave units, all three slave units will be controlled as if they were one speedlite in slave group A.

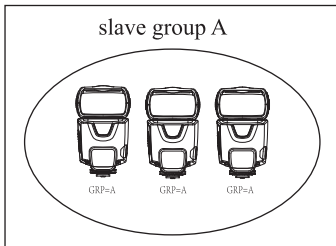

#### **4. Setting Manual Flash and Stroboscopic Flash with Wireless**

As the slave unit, YN500EX supports manual flash and Stroboscopic flash.

Manual flash: Set the master unit's flash mode to <M>, and set the flash output on master unit.

Stroboscopic: Set the master unit's flash mode to < Multi>, and set the flash output, stroboscopic flash count, stroboscopic flash frequency on master unit.

## 5. Shooting Examples with Wireless Flash System

- Master unit: 580-II, SB-900/800/700, 7D/60D/600D with built-in commander mode, Nikon c-commander and ST-E2.
- Slave unit: YONGNUO EX series flash, you can create three slave groups at all.
- Use the mini flash stand (tripod socket provided) to prop up the YN500EX speedlite.
- Swing the YN500EX so that its wireless sensor faces the master unit.
- Indoors, the wireless signal can also bounce off the wall so there is more leeway in positioning the YN500EX (s).
- After positioning the YN500EX(s), be sure to test the wireless flash operation before shooting.
- Don't place any obstacles between the master unit and slave unit(s). Obstacles can block the transmission of wireless signals.

## VIII. The Advanced Application

### 1. High-speed sync Flash

With high-speed sync (FP flash), the YN500EX can synchronize with all shutter speeds, the maximum shutter sync up to 1/8000. Setting method: Press the [High-speed/Rear-curtain sync] button to select HSS.

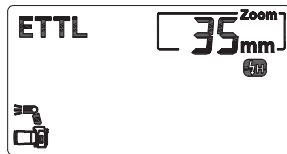



## **2. Ultra-long-range Wireless Flash**

YN500EX can receive remote wireless signal. The longest distance used indoors is 25 meters and the longest distance used outdoors is 15 meters.

Please note that the YN500EX's wireless sensor should be faced to master unit, and make sure it is within the effective range of transmission.

**NOTE:** As the slave unit, when YN500EX is used as Sc/Sn, the output level of speedlite is completely controlled by master unit.

## **3. Flash Exposure Compensation**

You can use the exposure compensation function of the camera to compensate flash output so as to make shooting effect better meet your requirements. you can also make compensation of flash brightness with the [LEFT] [RIGHT] button within the range of  $\pm 5\text{ev}$ , with the precision of  $1/3\text{ev}$  or  $1/2\text{ev}$ . Every press the button, the compensation setting will be display on LCD panel.

**NOTE:** For Canon version, please note that this compensation setting will override the exposure compensation setting on the camera.

## **4. Rear- curtain Sync**

You can use slow-speed shutter to produce trailing smear for the object and the flash light will flash at the moment when the shutter is going to be shut, which means the rear-curtain sync function .(For the rear-curtain sync setting, refer to your camera manual for setting). You can turn on or turn off the rear-curtain sync by pressing the

[High-speed/Rear-curtain sync] hotkey on panel of YN500EX.

NOTE: When YN500EX is used as slave unit, the rear-curtain sync function cannot be set.

## 5. Exposure Bracketing (FEB)

The FEB function is set on the camera or speedlite. For the specific setting method, refer to your Camera Instructions. After the FEB is set, after 3 photos are taken, exposure compensation will be made automatically in the sequence of, for example, “normal → under → over”. This function helps you improve the success rate of photo taking.

The setting method on the YN500EX speedlite: Press the [UP] [DOWN] button to adjust the exposure bracketing amount.

NOTE: For FEB, set the camera's drive mode to single shooting. Be sure the flash is ready before shooting.

## 6. FE Lock (Canon)

To use this function, cover the subject for which flash exposure will be locked at the center of the viewfinder of camera, press the button <\*> of the flash exposure lock, and the flash light will pre-flash and the camera will calculate the appropriate flash output data. Now you have some time for decomposition, after which, you can take photo. (The function can be used only when it is supported by your camera. For the setting method, refer to your Camera Instructions.)

## 7. FV Lock (Nikon)

Set the AE-L/AF-L function as FV Lock on the camera before using this function. At this time, you can aim at your desired object in the viewfinder and then press the AE-L key or AF-L key, in such case, the flash light will pre-flash to get the reading of flash exposure for the object; after you have confirmed the scene frame, press the shutter. (This function can only be available when your camera supports it; for the setting of AE-L and AF-L, refer to your camera manual).

## 8. Advanced Options Setting

YN500EX has advanced options function, you can customize speedlite function as you need, set advanced options with button group of the speedlite or camera menu access. Setting method of the buttons of the speedlite: Keep [Backlight/voice switch] for a long time and operate [MODE] to enter into the setting state of advanced options function, and the LCD screen shall show set items; such as: <SE oF 3> means the application at the roof, the speedlite shall automatically sleep if it is idle for 3 minutes, and automatically power off if it is idle for another 3 minutes after sleep.

Advanced options function supported by YN500EX is as following:

Fn NO.: 01

SL EP on: Auto power off is enabled

SP EP - - : Auto power off is disabled



Fn NO.: 03

Fb CL on: FEB auto cancel is enabled

Fb CL - - : FEB auto cancel is disabled

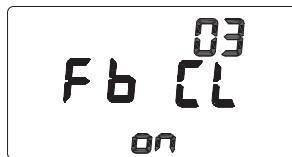

Fn NO.: 04

Fb 0 - +: Sequence of FEB is "0→-→+"

Fb - 0 +: Sequence of FEB is "-→0→+"

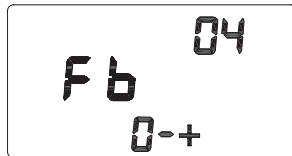

Fn NO.: 08

AF on: AF-assist beam firing is enabled

AF - - : AF-assist beam firing is disabled



Fn NO.: 09

AP S A1: Automatic identification enabled

AP S - - : Disable

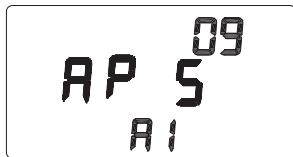

Fn NO.: 10

SL Sd 10: Power automatic off of the slave unit is 10 minutes

SL Sd 60: Power automatic off of the slave unit is 60 minutes

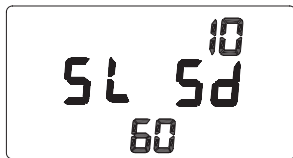

Fn NO.: 11

SL oF 1H: Slave auto power off cancel within 1 hours

SL oF 8H: Slave auto power off cancel within 8 hours

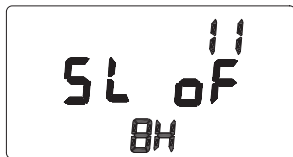

Fn NO.: 20

So nd on: Sound prompt function is enabled

So nd - - : Sound prompt function is disabled

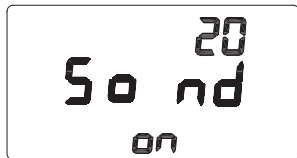

Fn NO.: E1

SE oF 3/5/10/30/1H/2H/3H/4H/5H: Keeping idle for 3/5/10/30 minutes or 1/2/3/4/5 hours will enter the dormancy mode, after it enters the sleep state, it powers off automatically after keeps the same idle time.

SE oF - - : NO dormancy, NO automatically turn off.

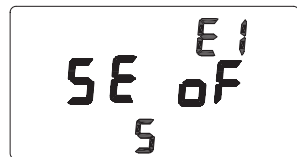

Fn NO.: E2

qu ic - - : Quick turn on / shut down function is disabled

qu ic on: Quick turn on / shut down function is enabled

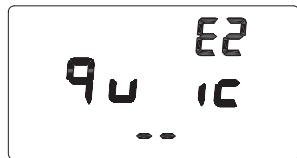

Fn NO.: E3

Lcd 7/15/30: The display time of LCD backlight is 7/15/30 seconds



Fn NO.: E5

CL EA - - : Recover the default settings

**Hold the [OK] button to recover the default settings.**

## 9. High-speed continuous shooting

The flash can realize the high-speed continuous shooting function. Please set the camera in the continuous shooting form and then shoot.

Please note: The number of photos that can be continuous shot is related with the output level. Please use the fully charged battery.

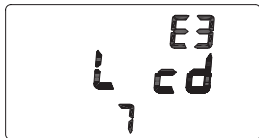

Fn NO.: E4

Inc 0.3: 0.3ev for fine-tuning step

Inc 0.5: 0.5ev for fine-tuning step

Inc on: Mix 0.3ev and 0.5ev for fine-tuning step



## 10. Reflection Flash

Bounce flash means to take photos by making flash light head aimed at wall or ceiling and using the light reflected back from the ceiling or wall to light the desired object, so that the shade behind the object can be decreased to get more natural shooting effect.

If the wall or ceiling is too far, the bounce flash may be too weak to get enough exposure. The wall or ceiling should be even and white in order to get efficient reflection; if the reflection surface is not white, color cast may appear in photo.

## 11. Use Reflection Board to Take Photos

With the reflection board flash, draw the reflection board and the wide-angle diffusion board out from the light head at the same time and then push the wide-angle diffusion board back. In such case, if this product is being used to take photos, it will produce a highlighted point on the eyes of the subject and thus make the eyes charming (catch light). This function can reach optimal effect when the flasher head is up 90°.

## 12. Use Wide-angle Diffuser

Pull out the wide-angle diffusion board, push back the reflection board and arrange them as per the figure; in such case, the flash scopes will extent to 18 mm and the flash effect extent will be softer and more natural.

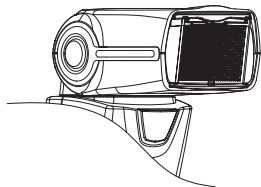
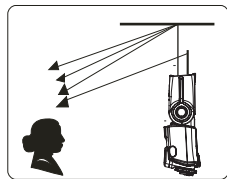
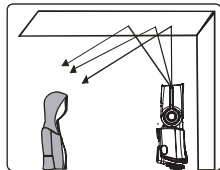



## IX Specifications

Circuit design	Insulated Gate Bipolar Transistor (IGBT)
Guide No.	53 (ISO 100, 105mm)
Flash mode	TTL, M, Multi, Sc, Sn S1, S2
Zoom range	Auto, 24, 35, 50, 70, 80, 105mm
Vertical rotation angle	-7~90 degrees
Horizontal rotation angle	0~270 degrees
Power supply	4×AAsize batteries (Alkaline or Ni-MH are usable)
Lighting times	100~1500 times (AA alkaline cell used)
Recycle time	Approx 3s (AA alkaline cell used)
Color temperature	5600k
Flash time	1/200s~1/20000s
Flash control	7 levels of output control (1/64 ~ 1/1), 25levels of fine tuning
External interface	hot shoe, PC port
Wireless triggering distance	20~25m indoor, 10~15m outdoor
Additional features	High-speed sync, Rear-curtain sync, FEC, FEB, FEV, the electronic flash head zooming, sound prompt, automatically saving setting, PC port, power saving mode, over heat protection, advanced setting.
Dimensions	62×72×165 mm (Extended state)
Net weight	320 g
Accessories	Flash light (1), protecting bag (1), mini stand (1) and manual (1)

Guide Number of different focal length range (at ISO 100, in meters / feet)

Flash Output	Flash Coverage (mm)						
	14	24	35	50	70	80	105
1/1	14/45.9	26/85.3	38/125.4	40/132	45/147.6	48/157.4	53/173.9
1/2	9.9/32.4	18.4/60.3	26.8/88.6	28.2/93.3	31.8/104.3	33.9/111.3	37.5/123
1/4	7 /23	13/42.6	19/62.7	20/66	22.5/73.8	24/78.7	26.5/86.9
1/8	4.9/16.1	9.2/30.2	13.4/44.3	14.1/46.6	15.9/52.2	17/55.7	18.7/61.4
1/16	3.5/11.5	6.5/21.3	9.5/31.3	10/33	11.2/36.8	12/39.3	13.3/43.6
1/32	2.4/7.8	4.6/15.1	6.7/22.1	7.1/23.3	7.9/26	8.5/27.8	9.4/30.8
1/64	1.7/5.7	3.2/10.5	4.7/15.6	5/16.5	5.6/18.3	6/19.7	6.6/21.7

## X. Possible problems during use and solutions

- 1. Please note when use the flash outdoors:** For outdoor application, please avoid direct sunlight to the wireless triggering sensor and ensure normal use of the flash.
- 2. Precaution for outdoor use of lambency umbrella:** The lambency umbrella mounted on the flash light outdoors may be blown down easily, and the hot shoe of the flash light may be broken. Please fix the mounting rack or avoid outdoor use.

**3. Photos are under exposure or over exposure?** Check if the set shutter, aperture and ISO are too near the flash limit or if some settings including exposure compensation in relation to flash are proper.

**4. Vignetting appears in photos or only part of the subject is illuminated?** Please check the current coverage of focal length and make sure if the lens focal length exceeds the coverage range of the flash. The product's zooming range is 24~105mm of the medium format system. You can try to pull out the wide-angle diffuser to expand the flash range.

5. You may feel the flash control panel is dim, because there is one protective film on the panel; you can tear it away to enjoy a clear visual effect.

**6. The flash light is abnormal?** Switch off the power of flash light and camera, mount the flash light on the hot shoe of camera, and switch on the power of flash light and camera again. If the abnormality continues, replace the batteries.

Update version of this manual can be got from [http://www.yongnuo.com.cn/usermanual/downloadIndex\\_en.htm](http://www.yongnuo.com.cn/usermanual/downloadIndex_en.htm)

The functions of this manual are based on test conditions of our company. Further notice will not be given if the design and specifications change.

The YONGNUO logo in this manual includes the registered trademark or trademark of **SHENZHEN YONGNUO PHOTOGRAPHY EQUIPMENT Co., Ltd** in China or/and other countries (regions). All other trademarks are the property of their respective owners.

